



### TECHNICAL DATA

<b>RATED FLOW [M3/H]</b>	4m3/hr
<b>MAX FLOW</b>	6m3/hr
<b>MAX HEAD</b>	78.7M
<b>OPTIMUM OPERATING RANGE</b>	2.41m3/hr @ 70.6m 39.7% eff 5m3/hr @ 58.8m 54.4% eff
<b>WORKING AIR TEMP</b>	0°C - 40°C
<b>LIQUID TEMPERATURE</b>	-15°C - 120°C
<b>HIGHEST EFFICIENCY</b>	54.3%
<b>MAXIMUM PUMP PRESSURE</b>	33 bar
<b>NET WEIGHT (KG)</b>	31.2kg

<b>RATED VOLTAGE/CURRENT</b>	Three phase 415V +10% - 6%
<b>RATED CURRENT</b>	3.04 amps
<b>POWER (KW)</b>	1.5kW 2 pole
<b>MOTOR IP RATING</b>	IP55
<b>MOTOR INSULATION</b>	Class F
<b>MOTOR EFFICIENCY STD</b>	I.E.3
<b>MOTOR EFFICIENCY</b>	84.2%
<b>COS Ø</b>	0.84
<b>MECHANICAL SEAL</b>	AS-L-12
<b>OUTLET DIN FLANGE</b>	DN32

### INCLUDES

- VMS Pump
- NXT Drive (Variable Frequency Drive)
- Counter Flange (In DN25 to DN65)
- Fiber Gaskets to suit counter flanges
- Watermarked Spring Check Valve
- Manifold (304 Stainless Steel)
- Pressure Transducer
- 30 Bar Liquid Filled Pressure Gauge
- Galvanised Single/Double/Triple Base
- Ball Valve (304 Stainless Steel)
- Pressure Tank Included in Scope of Supply
- Braided Hose 20 Bar 1.5m 1" BSPF with 10/6 model only

### DIMENSIONS

**BASE WIDTH & LENGTH** 275

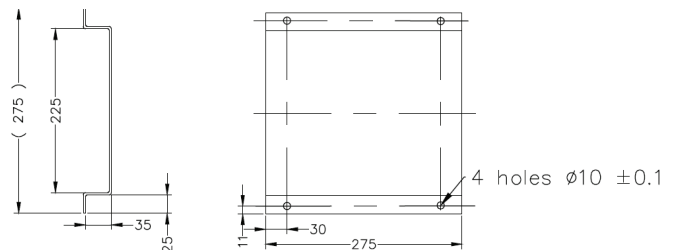

# PRODUCT DATA SHEET

SUMMIT SERIES VERTICAL MULTISTAGE

DRIVE KIT

BIA-1VMS5/7T-DRIVE • 812401

## CURVE

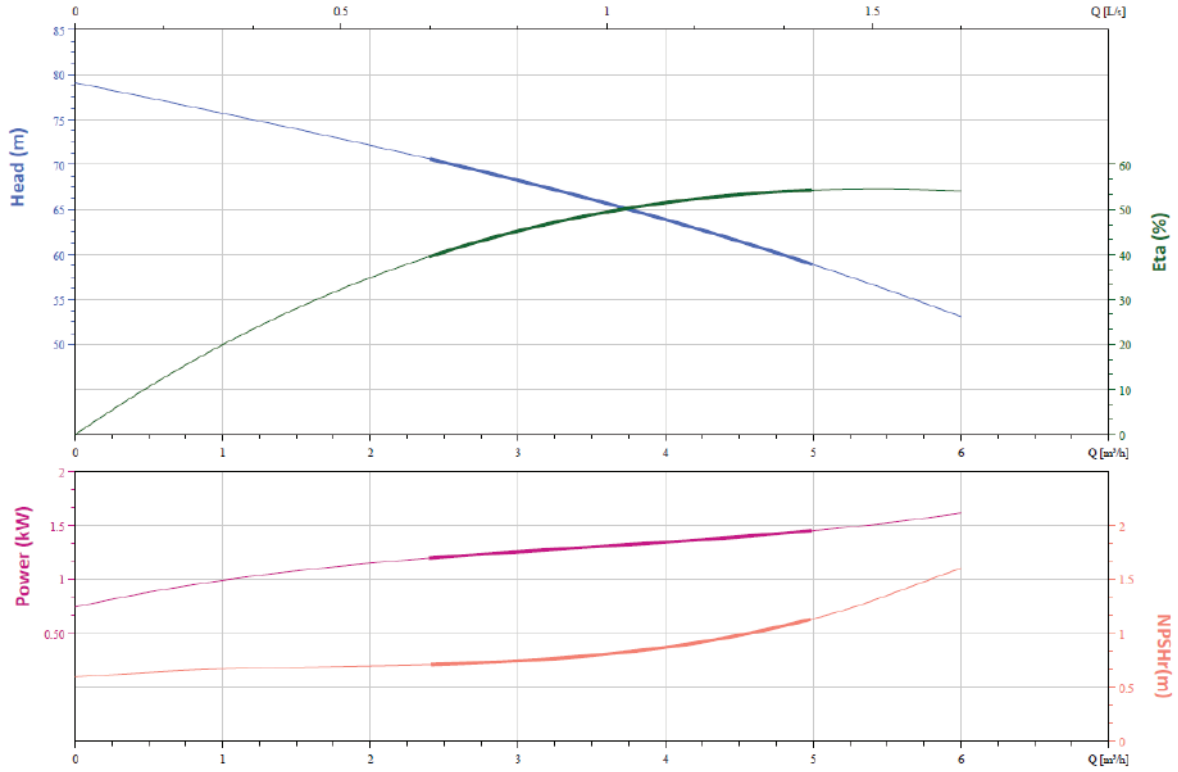

## VFD CURVE

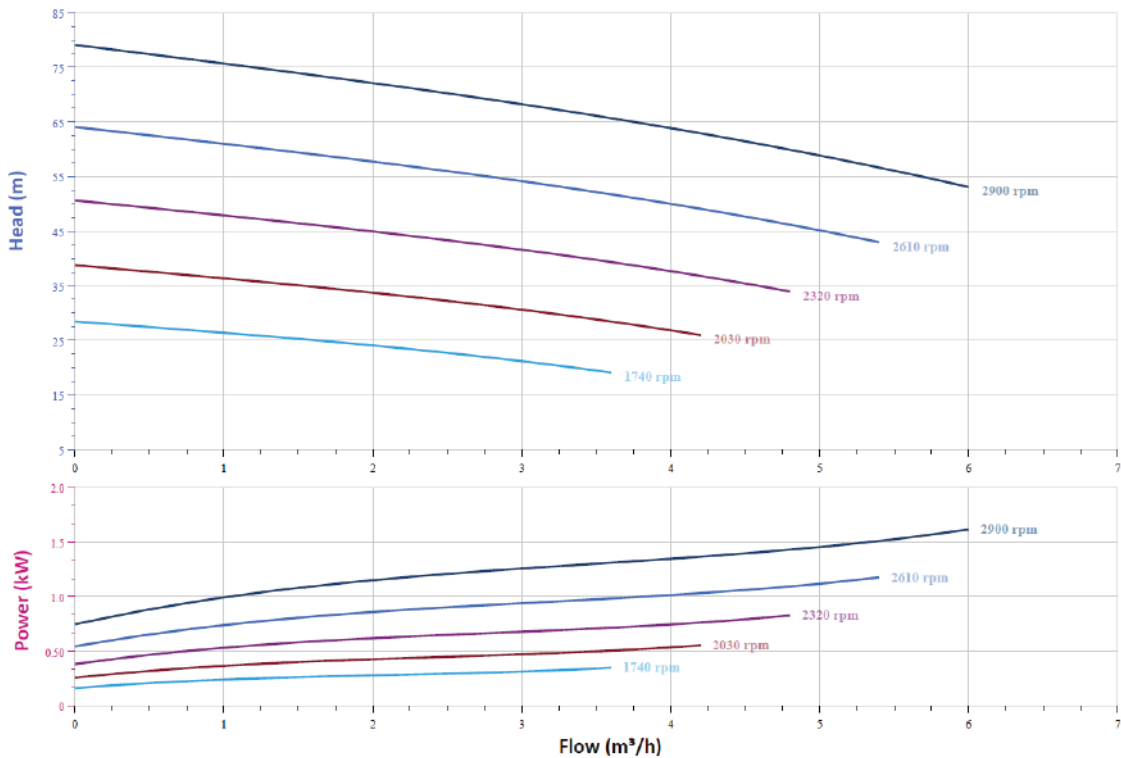

# PRODUCT DATA SHEET

SUMMIT SERIES VERTICAL MULTISTAGE

DRIVE KIT

BIA-1VMS5/7T-DRIVE • 812401

## DUAL PUMP CURVE

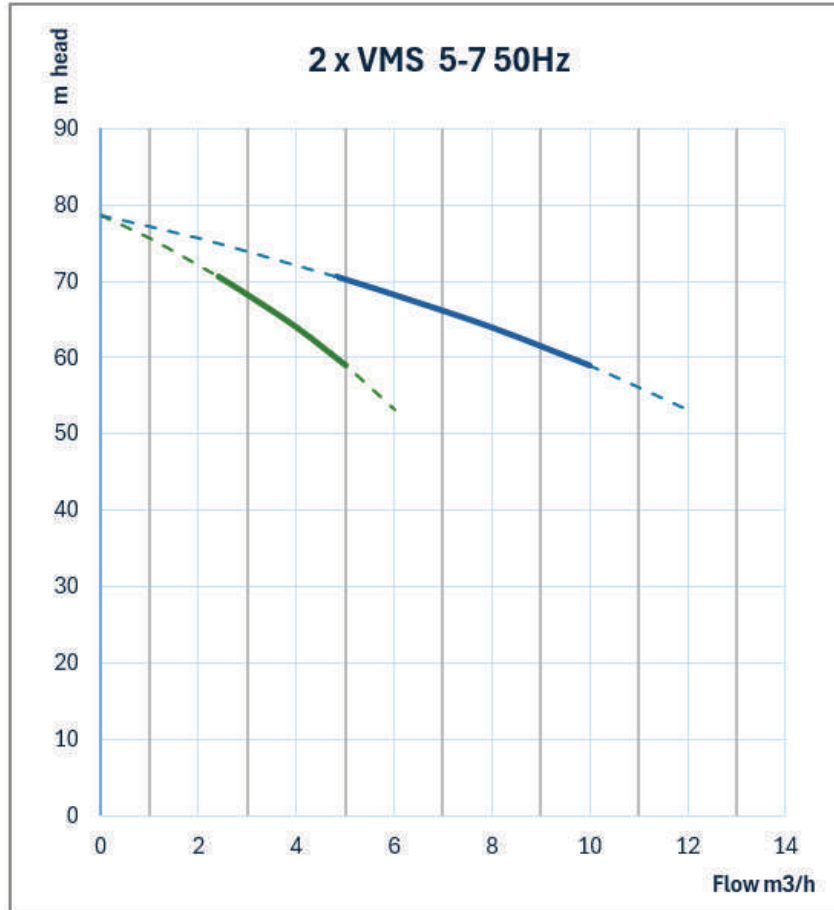

## CUTAWAY AND MATERIALS

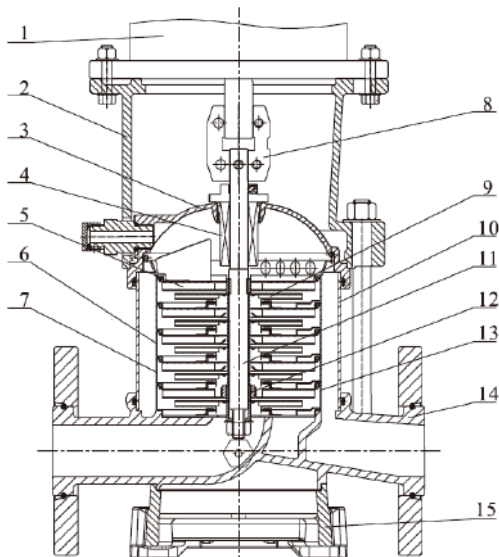

1	Motor	/
2	Bracket	Ductile Cast Iron
3	Seal Base	Stainless / Ductile Cast Iron
4	Mechanical Seal	AS-L-16
5	Top Diffuser	Stainless Steel
6	Diffuser	Stainless Steel
7	Support Diffuser	Stainless Steel
8	Coupling	Stainless Steel
9	Impeller	Stainless Steel
10	Cylinder	Stainless Steel
11	Shaft	Stainless Steel
12	Intermediate Bearing	SIC / WC
13	Inducer	Stainless Steel
14	Inlet/Outlet Chamber	Stainless Steel / Ductile Cast Iron
15	Base	Ductile Cast Iron

# PRODUCT DATA SHEET

SUMMIT SERIES VERTICAL MULTISTAGE

DRIVE KIT

BIA-1VMS5/7T-DRIVE • 812401

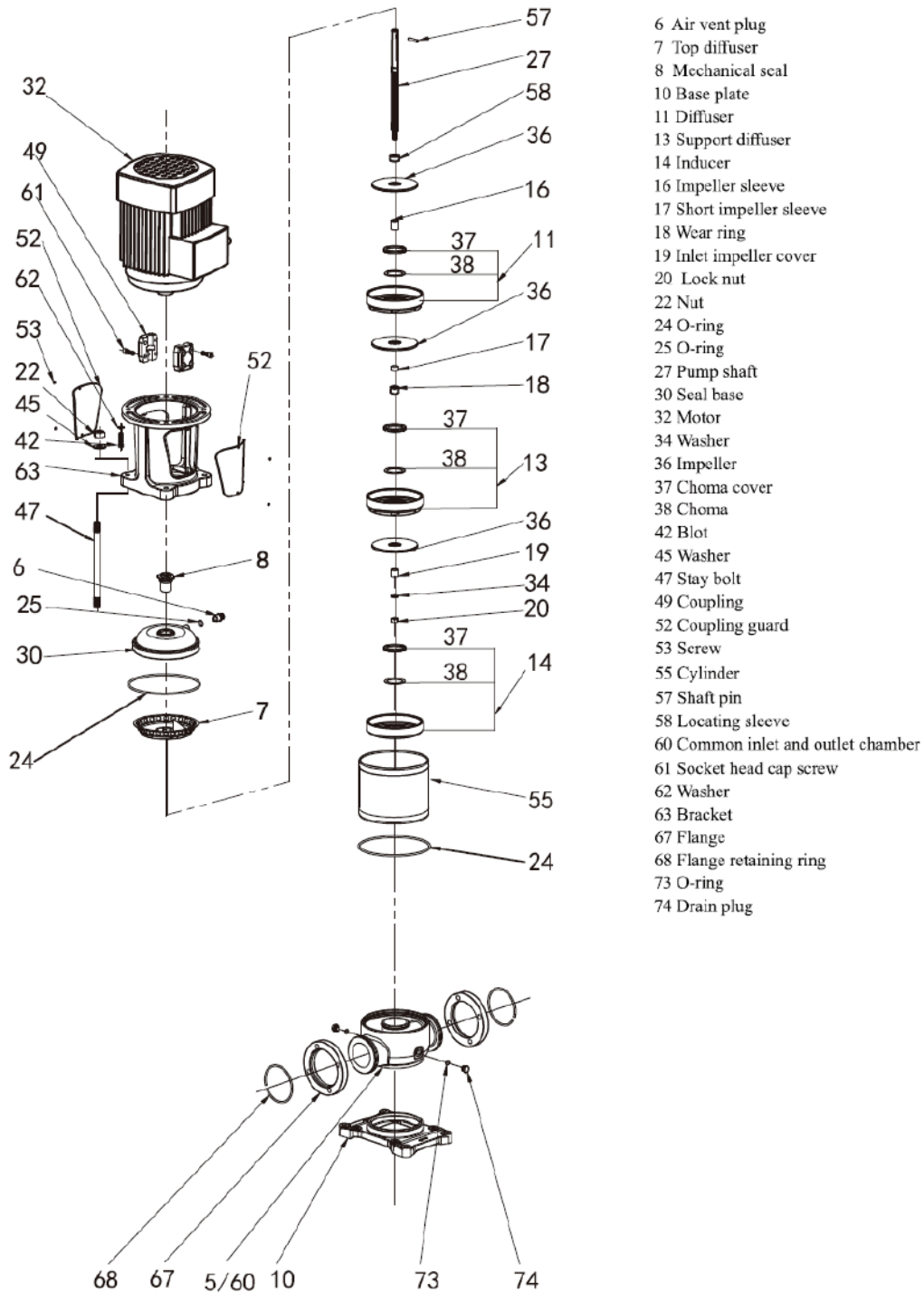

## WARRANTY / CERTIFICATIONS

